

VTC-1D user manual

The Variable Temperature Control (VTC-1D) automatically controls the temperature in a room by adjusting the speed of variable speed fans.

When the temperature is at the temperature set point, the VTC-1D operates the fans at the idle speed setting. When the temperature exceeds the set point, the VTC-1D increases the speed. When the temperature drops below the set point, the VTC-1D shuts off the fans (in shut-off mode) or operates the fans at idle speed (idle mode).

Features

- ◆ One variable speed output
- ◆ Automatic shut-off and idle modes
- ◆ Adjustable off set-back for shut-off mode
- ◆ Adjustable idle speed for idle mode
- ◆ Adjustable temperature set point
- ◆ Adjustable temperature differential
- ◆ Three-second full-power-turn-on to minimize fan ice-up
- ◆ Two-digit LED display
- ◆ Fahrenheit and Celsius display
- ◆ Error code display for troubleshooting
- ◆ Overload protection fuse
- ◆ Six-foot temperature probe, extendable to 500 feet
- ◆ Rugged enclosure (corrosion resistant, water resistant, and fire retardant)
- ◆ CSA approval
- ◆ Two-year limited warranty

Electrical ratings

- ◆ Input: 115/230 VAC, 50/60 Hz
- ◆ Variable stage: 10 A at 120/230 VAC, general-purpose (resistive)
7 FLA at 120/230 VAC, PSC motor
1/2 HP at 120 VAC, 1 HP at 230 VAC, PSC motor
- ◆ Fuse: 15 A, 250 VAC ABC-type ceramic



The FLA (full load ampere) rating accounts for the increase in motor current draw when the motor operates at less than full speed. Make sure the motor/equipment connected to the variable stage does not draw more than 7 FLA.

Installing the VTC-1D



The VTC-1D must be installed by a qualified electrician.

Before installing or servicing the VTC-1D, switch OFF the power supply at the source.

Install the VTC-1D and all equipment connected to it according to local electrical codes.



Mount the unit on a sheltered, vertical surface, with the electrical knockouts facing down.

Use a screwdriver to tighten the screws in the enclosure. Do not use a drill or over tighten the screws; this can crack the enclosure and ruin the watertight seal.

Use the electrical knockouts for bringing wires or cables into or out of the enclosure. Use watertight strain reliefs or conduit connectors at all cable-entry points.

Before removing electrical knockouts, remove the cover to prevent damaging the control. Do not make additional holes in the enclosure; this can damage the watertight seal or components and void the warranty.

Only permanent split capacitor motors appropriate for variable speed control, or shaded pole motors, can be used on the variable stages.

Fill out the information below to help configure your control and verify that you do not exceed the electrical ratings of the VTC-1D.

Fans	A Maximum current draw per fan	B Number of fans	A × B Total current draw
Make			
Model			
Voltage rating			
Power factor			

Mounting the VTC-1D

1. Remove the cover from the enclosure.
2. Fasten the VTC-1D to the mounting surface using the four screws provided.

Wiring the VTC-1D

1. Set the voltage switch **A** to the correct position for the line voltage used.
2. Set jumper **E** to the correct position for the temperature units (Fahrenheit or Celsius) you want to use.
3. Connect the incoming power and load wires as shown in the diagram.

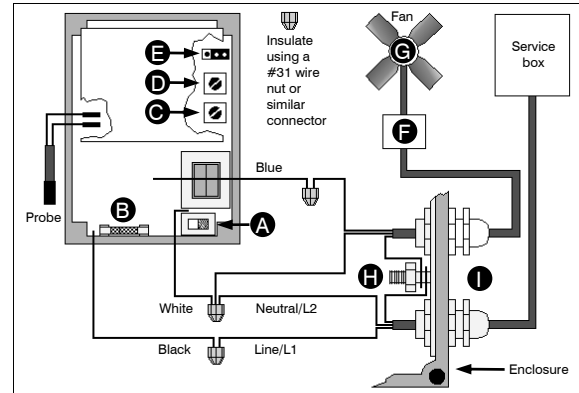

Connecting the temperature probe

Follow the guidelines below and connect the temperature probe as shown in the diagram.

- ◆ Do not run the probe cable in the same conduit as AC power cables
- ◆ Do not run the sensor cable beside AC power cables or near electrical equipment.
- ◆ When crossing other cables or power lines, cross them at a 90 degree angle.

A	Before connecting the power, set the switch to the correct setting	230 VAC	115 VAC
B	Fuse: 15 A, 250 VAC ceramic		
C	Temperature differential set	20°F / 1°F	16°F / 1°F
D	Off set-back/idle set mode		
E	Fahrenheit	<input type="checkbox"/>	Celsius <input type="checkbox"/>
F	Important: A suitable switch must be installed between the control and the motor. Important: Il est essentiel qu'un interrupteur convenable soit installé entre le contrôle et le moteur.		
G	Caution: For controlling shaded-pole, permanent-split-capacitor, or universal motors only. Caution: Destiné uniquement à la commande de moteurs universels. À bague de déphasage ou à condensateur permanent.		
H	Connect all ground wires to the grounding terminal located near the cable entry points.		
I	Use liquid-tight connectors at the cable entry points and seal with an RTV silicone.		

11150502

Using four-zone averaging

The VTC-1D can monitor the temperature in four different zones. The control takes an average of the four temperatures and operates according to the average temperature.

To use four-zone averaging, you must connect four temperature sensors to the unit. Connect the probes as shown to the right.

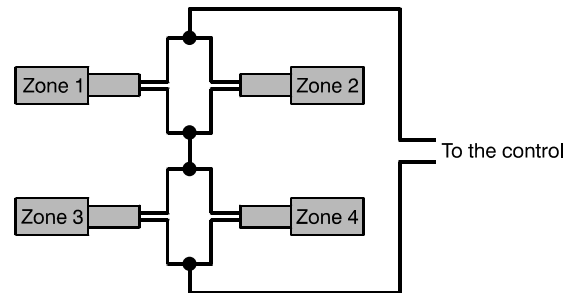

Extending probe cables

You can extend temperature probe cables to lengths of up to 500 feet. Follow the temperature probe guidelines and the guidelines below when extending cables.

- ◆ Use two-wire 18 AWG jacketed cable. Phason recommends Belden # 9408, Alpha # 5052, or an equivalent. Extension cable is also available from Phason. For more information, contact your dealer or Phason.
- ◆ If the unit operates erratically with the extended probe, run the cable along a different path or shorten it.

To extend probe cables

1. Slide three pieces of heat shrink tubing over the wires: one for the red wire, one for the black wire, and one for both.
2. Strip the ends of the wires and then twist them together.
3. Solder the wires together using rosin-core flux solder—DO NOT use acid core solder.
4. Slide the heat shrink tubing over the solder joints.
5. Shrink the tubing using a heat gun.

Getting started

When power is applied to the VTC-1D, the following displays:

1. **88** displays for approximately 0.25 seconds (start-up).
2. **00** displays for approximately 1 second (self-test).
3. **60** displays for approximately 1 second. The **60** indicates that the power system is 60Hz.
4. The display flashes between the temperature display and **PF**. The **PF** indicates a power interruption has occurred. To clear the **PF**, click the switch to the right.
The control is now in 'normal' mode.

Display alerts

Alert	Description
PS	The temperature probe or sensor cable has short circuited.
Pd	The temperature probe is damaged or the connecting wire is broken.
t5	<ul style="list-style-type: none"> ◇ The Temperature knob has accidentally been turned. The display will alternately flash t5 and the ambient temperature. The control will not accept the new setting until the switch is clicked to the set position. or ◇ The voltage switch is set to 230 volts, but the incoming power is 115 volts. Check the voltage switch.
PF	The power has been interrupted. The display will flash between PF and the temperature. To clear the alarm, click the switch to the right. The control will function normally.

Displaying and adjusting parameters

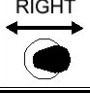
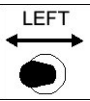
Switch position	Function
	<ul style="list-style-type: none"> ◇ Displays the ambient temperature
	<ul style="list-style-type: none"> ◇ Allows you to view and adjust the temperature set point ◇ Clears alarms
	<ul style="list-style-type: none"> ◇ Allows you to view and adjust the differential (<i>d t</i>), off set-back (<i>o5</i>), and idle speed (<i>id</i>). Each time the switch is clicked and then held in this position, the next parameter is displayed. The display flashes between the parameter code (two letters) and its setting (two digits). You can adjust the parameter at this point. The cycle starts over after the last parameter. To restart at the beginning of the cycle, click the switch to the right.

Parameter	Code	Range	Factory setting	Location
Temperature set point	N/A	32 to 99°F (0 to 38°C)	N/A	External knob
Idle speed	<i>id</i>	0 - 99%	N/A	External knob
Temperature differential	<i>d t</i>	1 to 20°F (0.6 to 12°C)	6°F	Internal trimmer
Off set-back	<i>o5</i>	0 to 16°F (0 to 9°C)	5°F	Internal trimmer
°F or °C (ambient temp.)	°F / °C	-22 to 99°F (-30 to 38°C)	°F	Internal jumper

About hysteresis

The VTC-1D has a 1°F (0.5°C) hysteresis. This means the fan will turn off 1°F below the temperature at which it turned on.

For example, if temperature set point is 75°F, the fan turns on at 75°F, off at 74°F. This prevents the fan from flickering on and off when the temperature is at the set point.

Setting the off set-back and selecting the mode of operation

Auto shut-off (OSB) mode

In auto shut-off mode, also called OSB mode, the fan shuts off when the temperature is below the off set-back temperature. For more information, see **Example 1: shut-off (OSB) mode** on page 9.

Idle mode

In idle mode, the fan runs at the idle speed when the temperature is below the temperature set point. For more information, see **Example 2: idle mode** on page 10.

To set the mode of operation

1. Press the switch to the right to start at the beginning of the parameter list.
2. Press the switch to the left two times and then hold.
For auto shut-off mode, the display flashes between **o5** and the setting. For idle mode, the display shows **ld**.
3. To set the control for auto shut-off mode, turn the trimmer to the desired off set-back using a small, flat screwdriver. To set the control for idle mode, turn the trimmer fully clockwise. See section D of the diagram on page 3 for the location.

Setting the temperature set point

The temperature set point is the desired temperature. It is also the reference for the off set-back and differential temperature settings.

For more information, see **Example 1: shut-off (OSB)** mode on page 9 and **Example 2: idle mode** on page 10.

To display and adjust temperature set point

1. Press and hold the switch to the right.
2. Turn the **Temperature** knob to the desired setting while holding the switch to the right. The temperature set point can be between 32 and 98°F (0 and 38°C).
3. Release the switch.



You must hold the switch to the right while turning the knob. If this is not done correctly, the display flashes between **t5** and the temperature display. This means the knob has been turned without holding the switch. The control will not accept the new setting until the switch is clicked to the right.

Setting the differential temperature

The differential is the number of degrees above the temperature set point that the fan reaches maximum speed. For example, if the temperature set point is 80°F and the differential is 6°F, the fan will be at maximum speed at 86°F. For more information, see **Example 1: shut-off (OSB)** mode on page 9 and **Example 2: idle mode** on page 10.

To display and adjust the differential

1. Press the switch to the right to start at the beginning of the parameter list.
2. Press and hold the switch to the left.
The display flashes between **d1** and the setting.
3. Adjust the internal trimmer using a small flat screwdriver. See section C of the diagram on page 3 for the location.



The difference in motor power factors can cause the actual differential to be less than the displayed value. If the power factor of the motor is available, use the correction numbers and formula below to calculate the correct differential setting.

Power factor	1.0	0.9	0.8	0.7	0.6	0.5
Correction (°F)	1.00	1.05	1.10	1.25	1.33	1.60

actual differential = desired differential × correction

Example 1

- ◇ To have an actual differential of 6°F with a motor that has a power factor of 0.7, set the differential to 7.5°F.
- ◇ $6^{\circ}\text{F} \times 1.25 = 7.5^{\circ}\text{F}$

Example 2

- ◇ To have an actual differential of 5°F with a motor that has a power factor of 0.5, set the differential to 8.0°F.
- ◇ $5^{\circ}\text{F} \times 1.6 = 8.0^{\circ}\text{F}$

If you do not know the power factor, calculate the correction as follows:

1. Set the idle speed properly. For more information, see **Setting minimum ventilation in idle mode** on page 8.
2. Set the differential to 10°F with the internal trimmer. Note the temperature (**T1**) in the digital display.
3. Press and hold the switch to the right and adjust the temperature set point to equal the temperature from step 2. The fan operates just above the idle speed.
4. Slowly decrease the temperature set point and listen to the fan increase in speed. When the motor reaches full speed, note the temperature set point (**T2**).
5. Calculate the correction using the following formula.
Correction = $10^{\circ}\text{F} \div (\mathbf{T2} - \mathbf{T1})$

Example 3

- ◇ For a T1 temperature of 75°F and a T2 temperature of 82°F, the correction is 1.43.
- ◇ $10^{\circ}\text{F} \div (82^{\circ}\text{F} - 75^{\circ}\text{F}) = 1.43$
- ◇ If the desired differential is 5°F, the actual differential can be calculated as follows: $5^{\circ}\text{F} \times 1.43 = 7.15^{\circ}\text{F}$.
- ◇ Set the differential to 7°F for an actual differential of 5°F.

Setting minimum ventilation in auto shut-off mode

There must be a temperature probe connected before adjusting the minimum ventilation.

To adjust the idle speed

1. Turn the **Idle Speed** knob fully counter-clockwise and then 1/4 turn clockwise.
2. Press and hold the switch to the right
3. Turn the **Temperature** knob fully clockwise while holding the switch to the right.
4. Release the switch.
The fan should be off.
5. Press and hold the switch to the right.
6. Slowly turn the **Temperature** knob counter-clockwise. When the fan runs at full speed, stop turning the knob and release the switch.
The fan runs at full speed for approximately three seconds and then at the idle speed. The **Temperature** knob should be approximately one degree higher than the display temperature.
7. Slowly adjust the **Idle Speed** knob until the fan runs at the proper idle speed.
A voltmeter is helpful for determining the voltage. If you are unsure, see your fan dealer for the minimum idle voltage for your fan motor.
8. Press and hold the switch to the right.
9. Turn the **Temperature** knob to the desired temperature set point while holding the switch to the right.
The temperature set point can be between 32 and 98°F (0 and 38°C).

Setting minimum ventilation in idle mode

There must be a temperature probe connected before adjusting the idle speed.

To adjust the idle speed

1. Turn the **Idle Speed** knob fully counter-clockwise.
2. Press and hold the switch to the right
3. Turn the **Temperature** knob fully clockwise while holding the switch to the right.
4. Release the switch.
The fan should be running at idle speed.
5. Slowly adjust the **Idle Speed** knob until the fan runs at the proper idle speed.
A voltmeter is helpful for determining the voltage. If you are unsure, see your fan dealer for the minimum idle voltage for your fan motor.
6. Press and hold the switch to the right.
7. Turn the **Temperature** knob to the desired temperature set point while holding the switch to the right.
The temperature set point can be between 32 and 98°F (0 and 38°C).

Operation

Example 1: shut-off (OSB) mode

Set point	Differential	Off set-back	Idle speed
80°F	6°F	5°F	20%

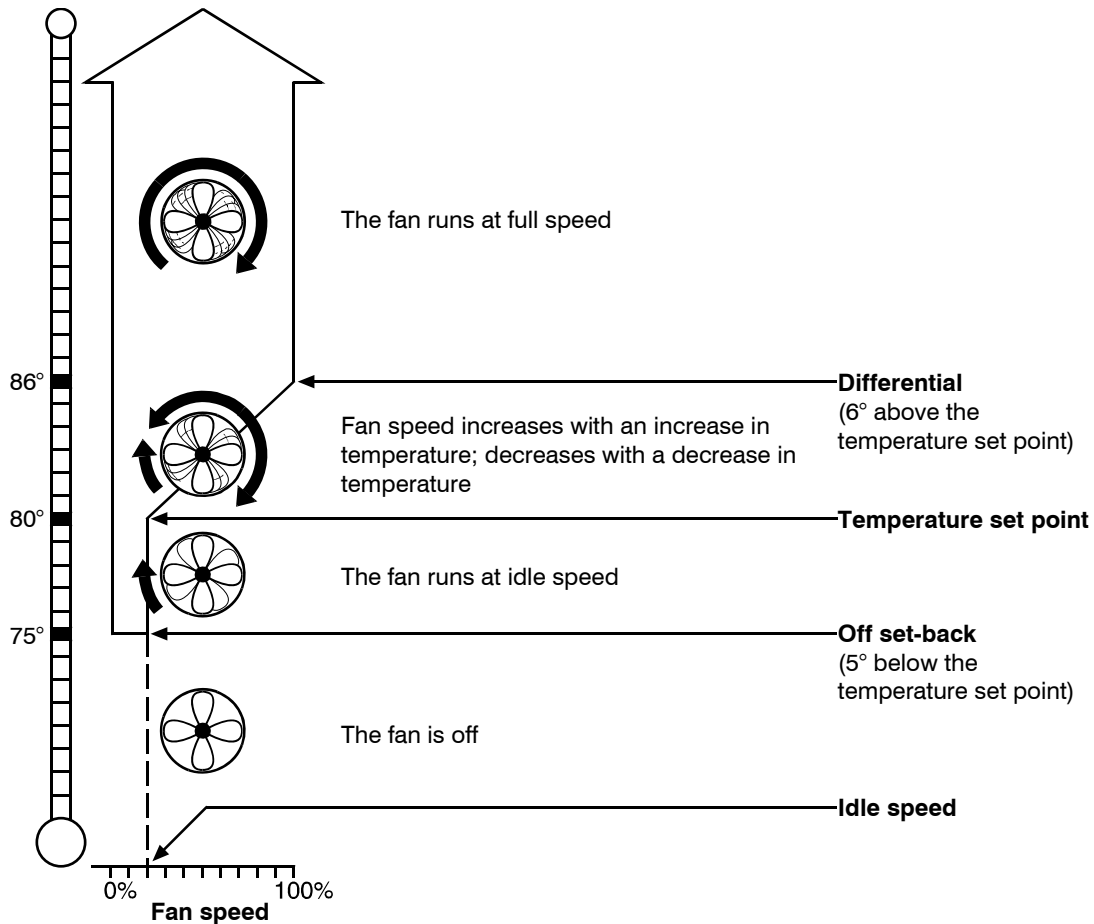

- ◆ When the temperature is below 75°F, the fan is off.
- ◆ When the temperature increases to 75°F (the off set-back temperature) the fan operates at full speed for three seconds (for de-icing), then at idle speed (20%). The fan runs at idle speed when the temperature is between 75°F and 80°F (the temperature set point).
- ◆ When the temperature is between 80°F and 86°F (the differential temperature), fan speed changes proportionally with the temperature. If the temperature increases, fan speed increases. If the temperature decreases, fan speed decreases.
- ◆ When the temperature is at or above 86°F, the fan operates at maximum speed.

Example 2: idle mode

Set point	Differential	Off set-back	Idle speed
80°F	6°F	off	20%

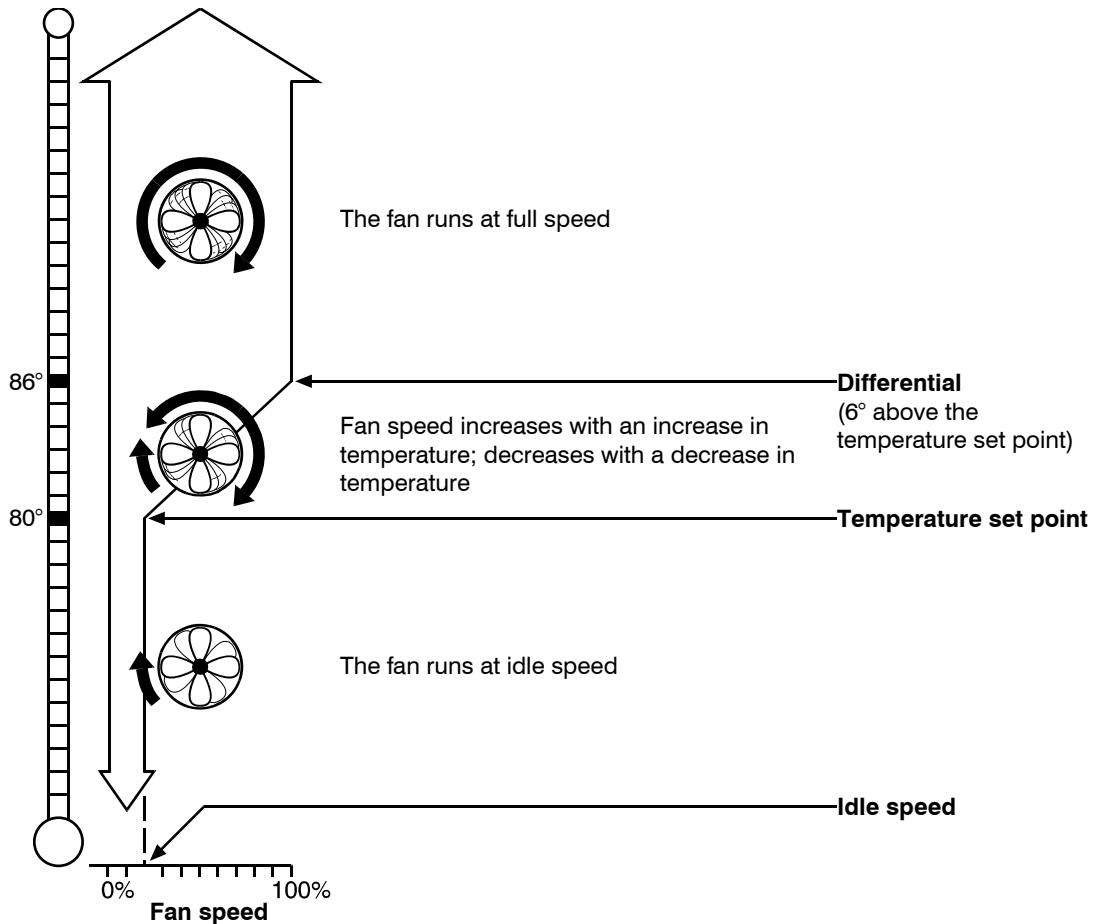

- ◆ When the temperature is below 80°F (the temperature set point), the fan operates at idle speed.
- ◆ When the temperature is between 80°F and 86°F (the differential temperature), fan speed changes proportionally with the temperature. If the temperature increases, fan speed increases. If the temperature decreases, fan speed decreases.
- ◆ When the temperature is at or above 86°F, the fan operates at maximum speed.

Maintaining the VTC-1D

Proper care and maintenance will help your VTC-1D last longer. To prevent damage to the control, perform the following steps after the first two weeks of operation, and once a year after that.

1. Switch off the power to the control.
2. Remove the cover and check inside for moisture. If there is any moisture, wipe it away using a dry cloth.
3. Check all cable entry points to make sure they are properly sealed. If they are not properly sealed, apply silicone sealant around the entry points.



If you need to seal the enclosure, use a sealant that is labelled as 'non-corrosive', 'electronics grade', or 'neutral cure', such as GE Silicone RTV6780B, RTV 142, or RTV 162.

Do not use a sealant that is labelled as 'acetic acid cure' or 'acetoxycure'. These sealants release acetic acid while curing, which can damage the control and will void the warranty.

4. Check all wires to make sure they are properly connected and that they are in good condition.
5. Fasten the cover to the enclosure and then switch on the power to the control.

Cleaning the VTC-1D

To clean the VTC-1D, wipe the surface with a damp cloth.



Be careful when washing the room using a high-pressure washer. **DO NOT** spray the control using a high-pressure washer, this can damage the control and will void the warranty.

Evidence of moisture damage inside the control will void the warranty.

Limited warranty

This warranty applies only to the Phason Inc. (Phason) Variable Temperature Control (VTC-1D). If you need warranty service, return the product and original proof of purchase to your dealer.

Phason warrants the VTC-1D subject to the following terms and conditions.

This warranty is valid only to the original purchaser of the product, for two years from the manufacturing date. The manufacturing date is stated in the first eight digits of the serial number in the form year-month-day.

Phason hereby warrants that should this product fail because of improper workmanship, Phason will repair the unit, effecting all necessary parts replacements without charge for either parts or labor.

Conditions

- ◆ Installation must be done according to Phason's enclosed installation instructions.
- ◆ The product must not have been previously altered, modified, or repaired by anyone other than Phason.
- ◆ The product must not have been involved in an accident, misused, abused, or operated or installed contrary to the instructions in our user and/or installation manuals. Phason's opinion about these items is final.
- ◆ The person requesting warranty service must be the original purchaser of the unit, and provide proof of purchase upon request.
- ◆ All transportation charges for products submitted for warranty must be paid by the purchaser.

Except to the extent prohibited by applicable law, no other warranties, whether expressed or implied, including warranties of merchantability and fitness for a particular purpose, shall apply to this product. Any implied warranties are excluded.

Phason is not liable for consequential damages caused by this product.

Phason does not assume or authorize any representatives, or other people, to assume any obligations or liabilities, other than those specifically stated in this warranty.

Phason reserves the right to improve or alter the VTC-1D without notice.

Phason controls are designed and manufactured to provide reliable performance, but they are not guaranteed to be 100 percent free of defects. Even reliable products can experience occasional failures and the user should recognize this possibility.

If Phason products are used in a life-support ventilation system where failure could result in loss or injury, the user should provide adequate back up ventilation, supplementary natural ventilation, or an independent failure-alarm system. The user's lack of such precautions acknowledges their willingness to accept the risk of such loss or injury.

Phason Inc.

2 Terracon Place

Winnipeg, Manitoba, Canada
R2J 4G7

Phone: 204-233-1400

Fax: 204-233-3252

E-mail: support@phason.ca

Web site: www.phason.ca